

Kalle 40 (561x330)

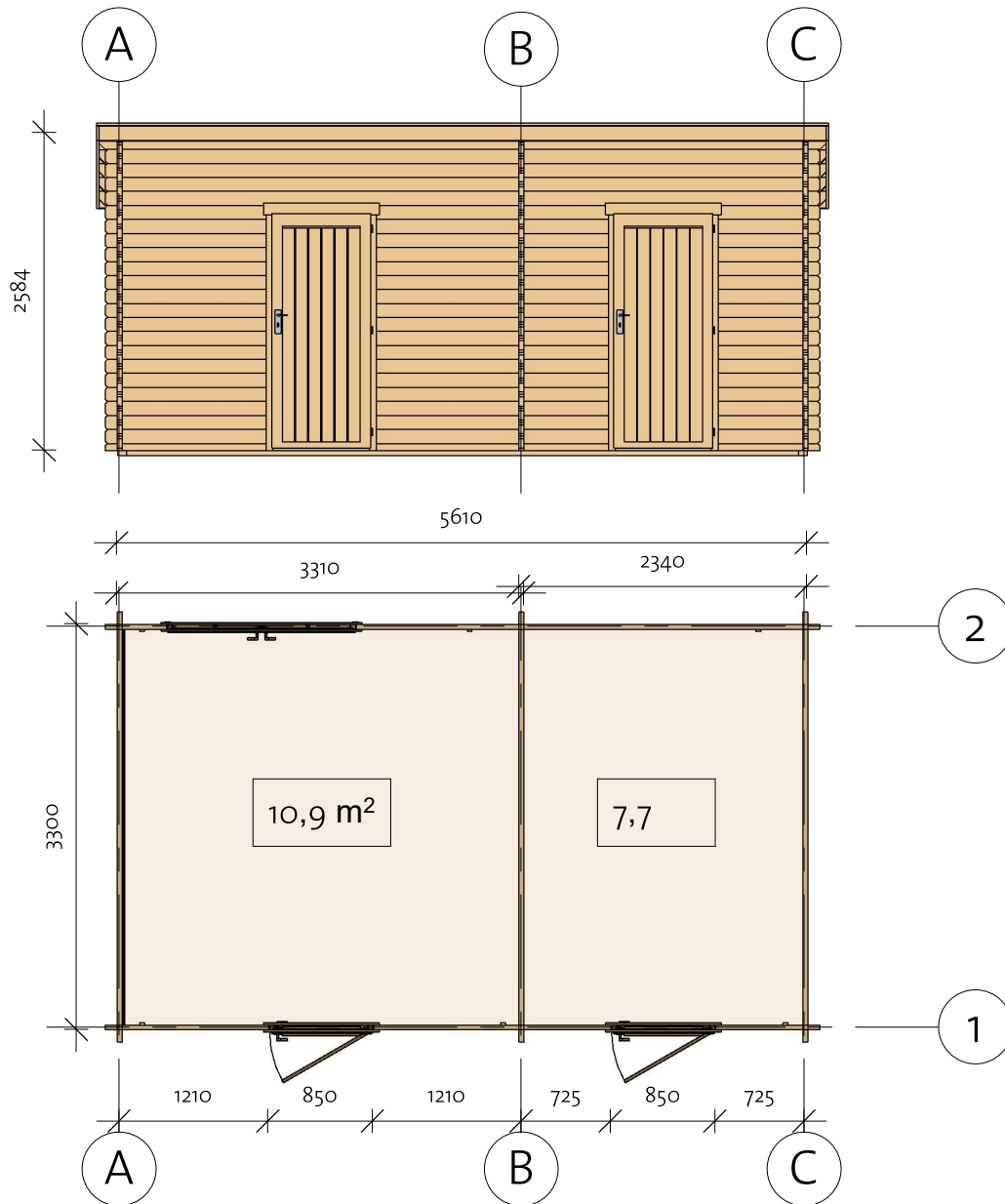

Kalle 40 (561x330)

Foundation

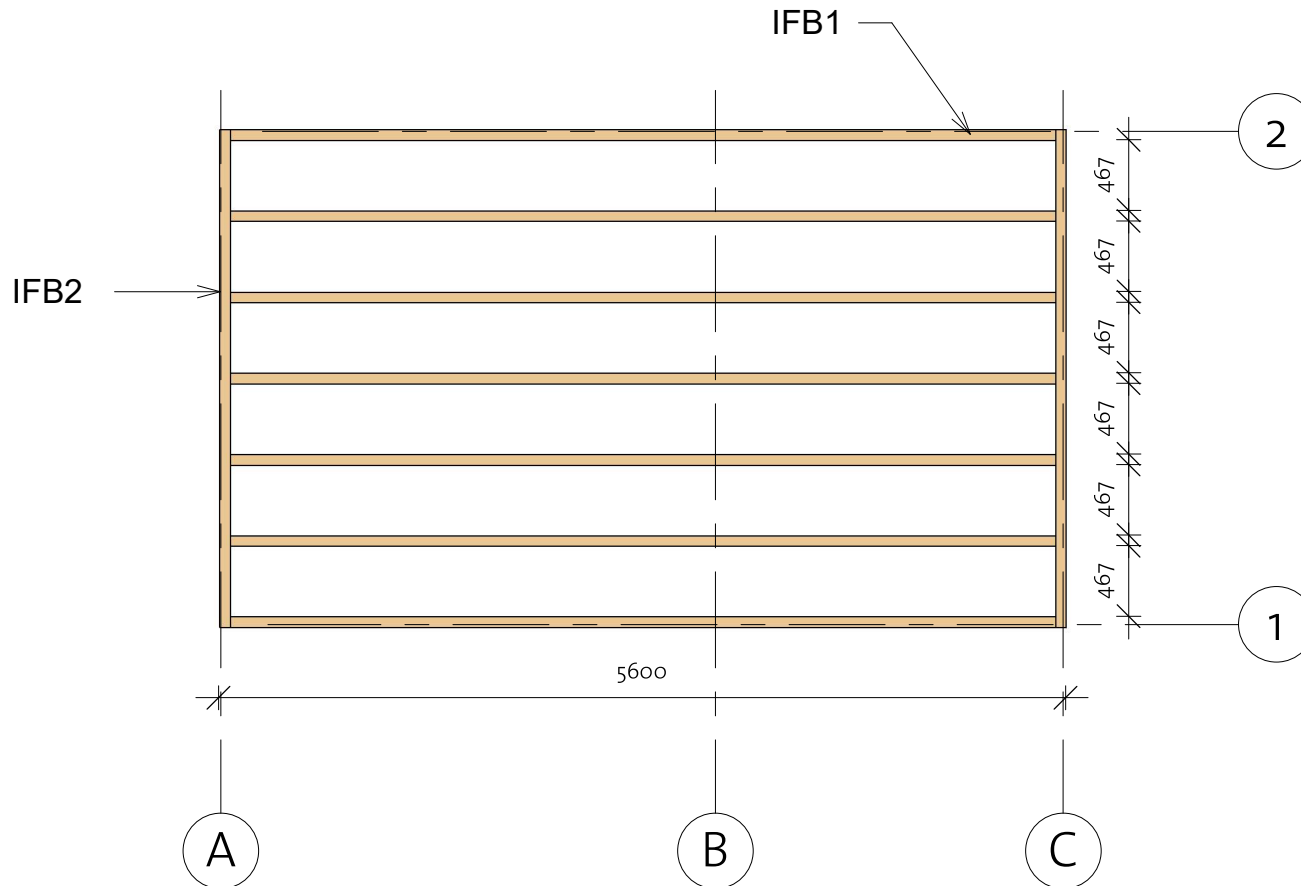

Impregnated foundation beams				
Mark	Type	Profile	Count	Length

IFB1	IFB 70x40		7	5460
IFB2	IFB 70x40		2	3290



Kalle 40 (561x330)

Floor Plan

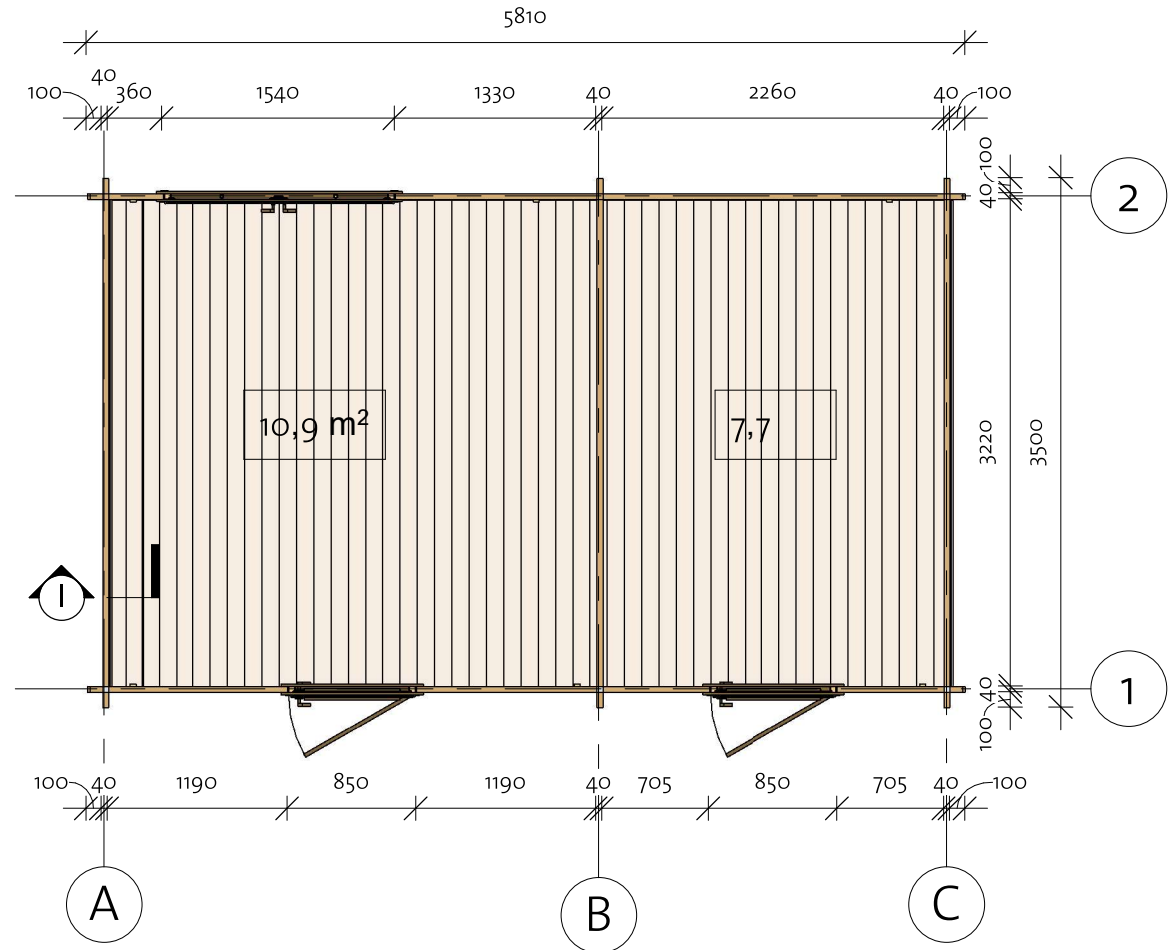
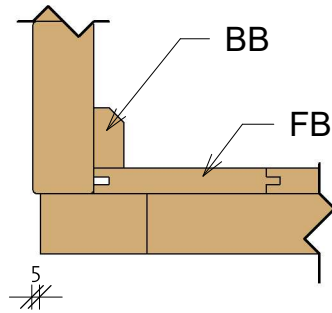
① Baseboard



Floor Schedule

Mark	Type	Profile	Count	Length
FB	FB 17x114		52	3214
BB1	BB 20x40		2	5610
BB2	BB 20x40		4	3300

Kalle 40 (561x330)

Wall 1

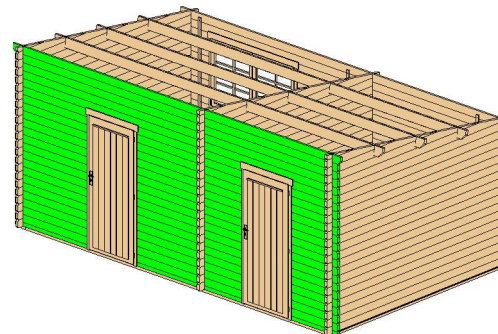

Wall 1			
Mark	Profile	Count	Cut Length
1BL-1	40X57	1	1330
1BL-2	40X57	1	1935
1BL-3	40X57	1	845
1LG-1	40X114	17	845
1LG-2	40X114	17	1935
1LG-3	40X114	17	1330
1LG-4	40X114	4	5810
1TL-1	40X114	1	5910

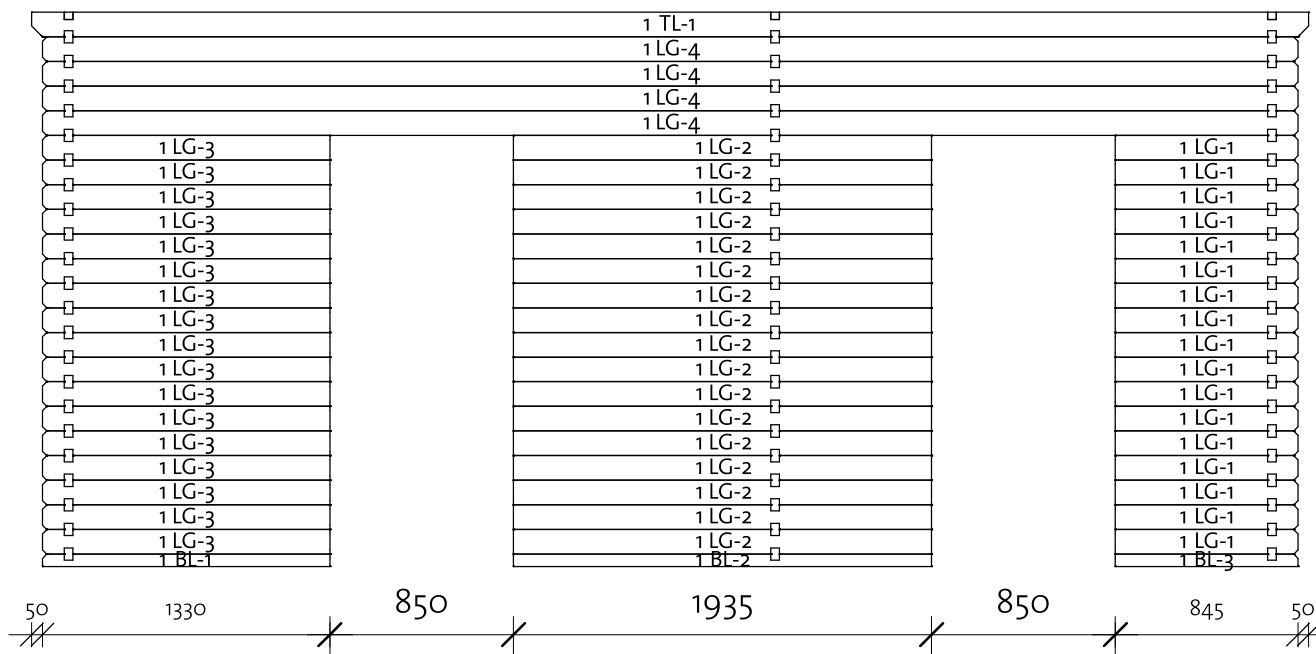

Log Profile Wall 1	
Profile	Profile

40X114	
40X114	
40X57	

Kalle 40 (561x330)

Wall 2

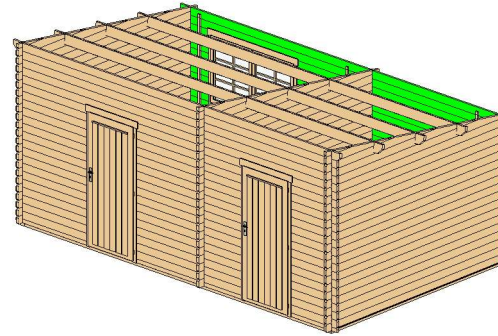

Wall 2			
Mark	Profile	Count	Cut Length

2BL-1	40x57	1	5810
2LG-1	40x114	9	500
2LG-2	40x114	9	3770
2LG-3	40x114	8	5810
2TL-1	40x114	1	5910

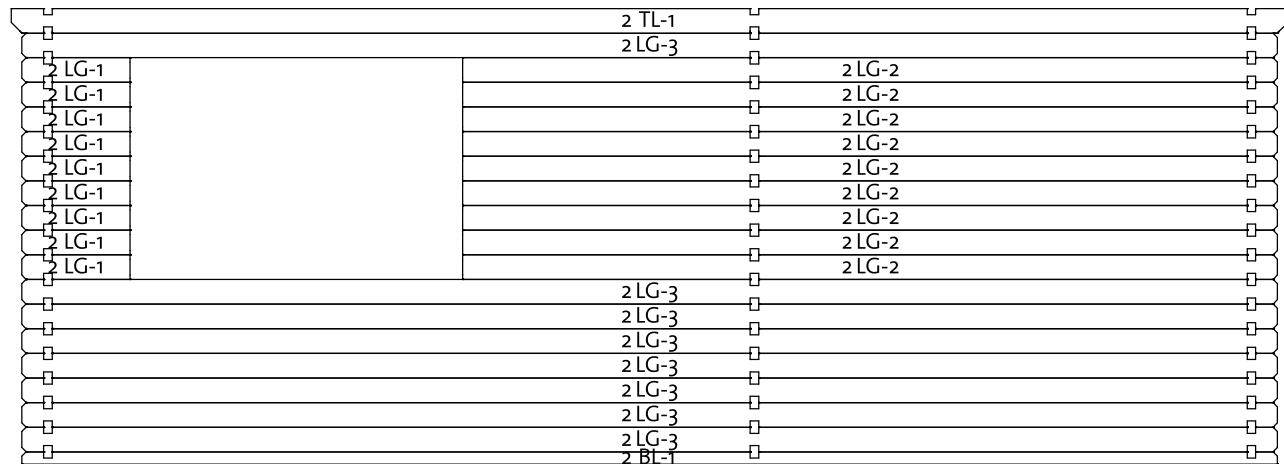

Log Profile Wall 2	
Profile	Profile

40x114	
40x114	
40x57	

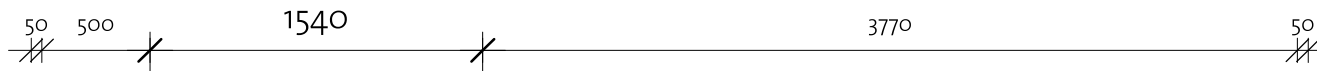

Kalle 40 (561x330)

Wall A

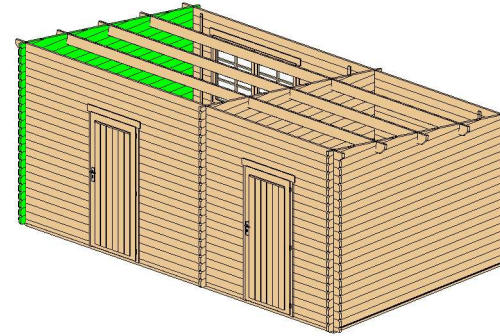

Wall A			
Mark	Profile	Count	Cut Length

ALG-1	40x114	1	509
ALG-2	40x114	1	1323
ALG-3	40x114	1	2138
ALG-4	40x114	1	2953
ALG-5	40x114	1	3500
ALG-6	40x114	18	3500

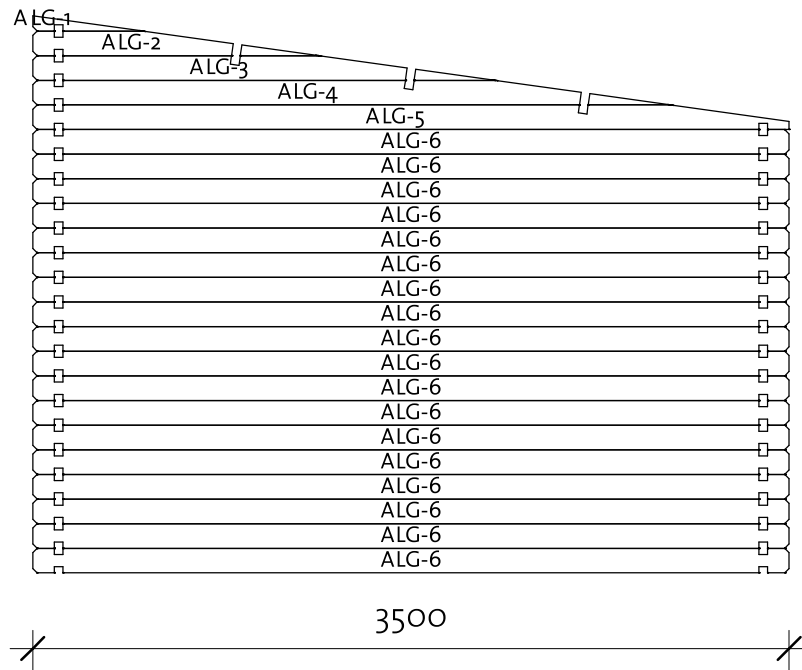

Log Profile Wall A	
Profile	Profile

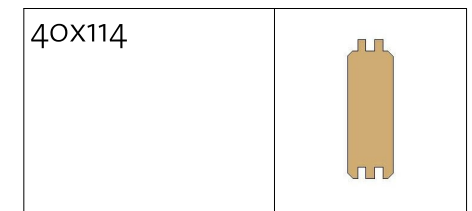

Kalle 40 (561x330)

Wall B

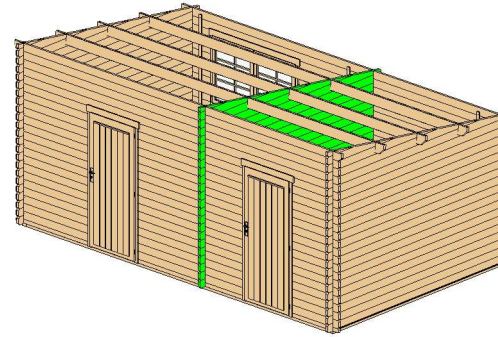

Wall B			
Mark	Profile	Count	Cut Length

BLG-1	40x114	1	509
BLG-2	40x114	1	1323
BLG-3	40x114	1	2138
BLG-4	40x114	1	2953
BLG-5	40x114	1	3500
BLG-6	40x114	18	3500

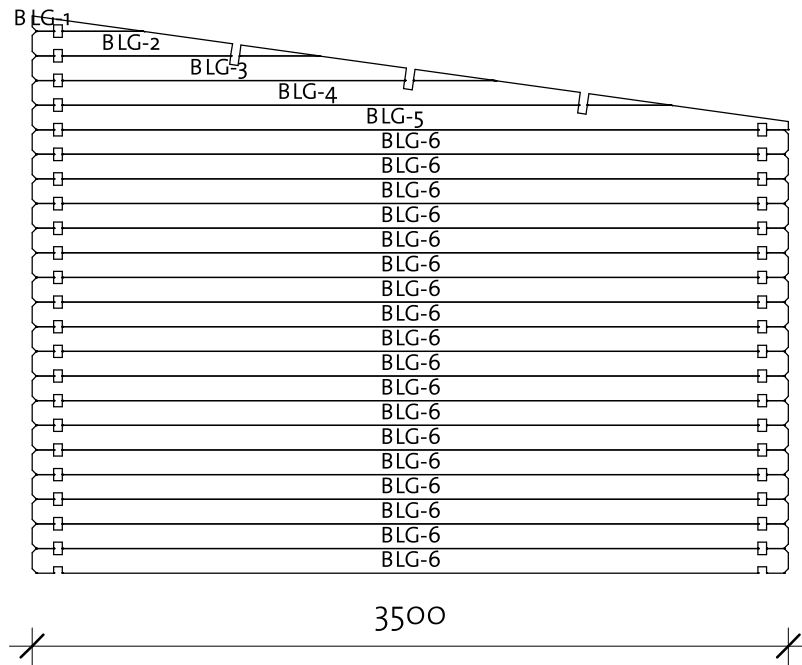

Log Profile Wall B	
Profile	Profile

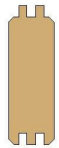
40x114	
--------	---

Kalle 40 (561x330)

Wall C

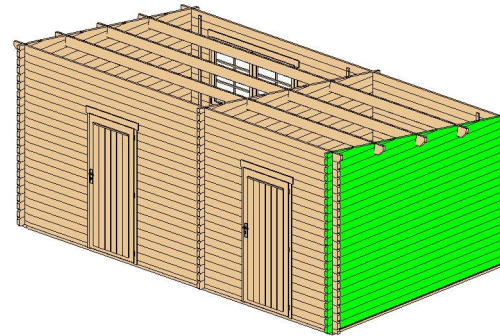

Wall C			
Mark	Profile	Count	Cut Length

CLG-1	40x114	1	509
CLG-2	40x114	1	1323
CLG-3	40x114	1	2138
CLG-4	40x114	1	2953
CLG-5	40x114	1	3500
CLG-6	40x114	18	3500

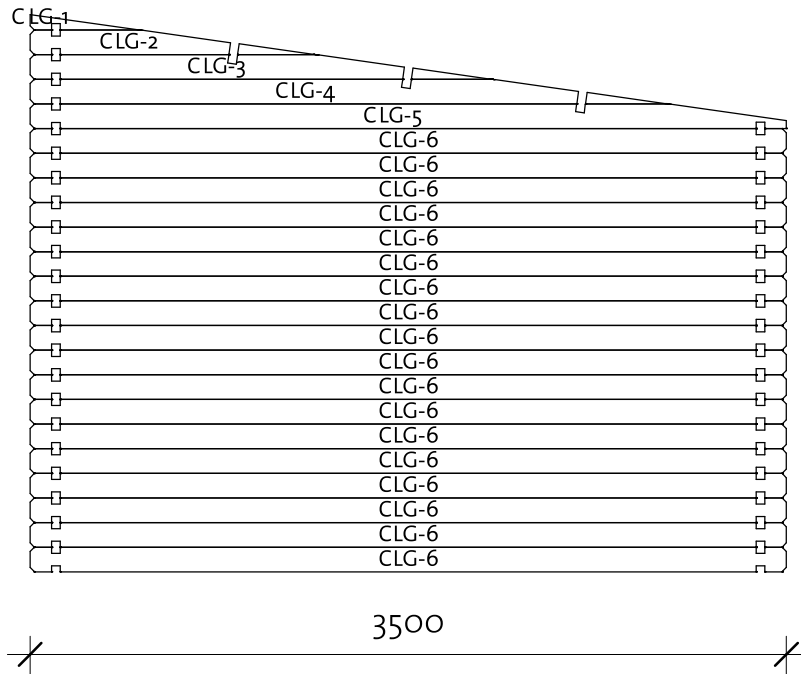



Log Profile Wall C	
Profile	Profile

40x114	
--------	--

Kalle 40 (561x330)

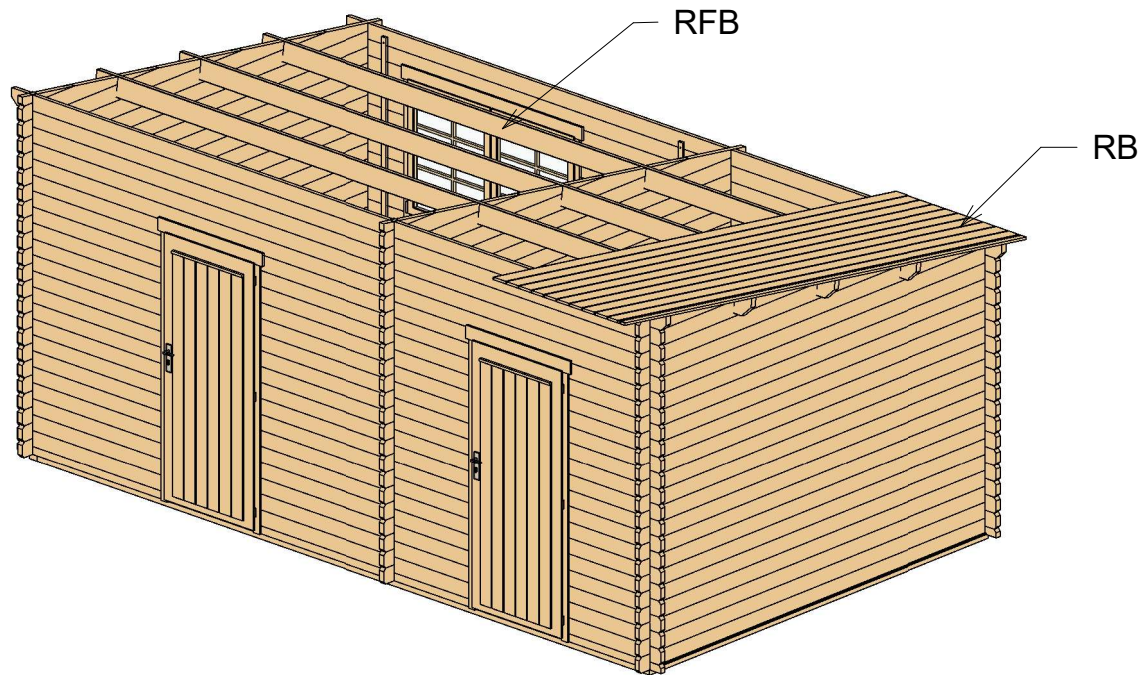
Roof 1



Roof				
Mark	Type	Profile	Count	Length
RFB	Beam 40x143		3	5910
RB	17x114		53	3936

Kalle 40 (561x330)

Roof 2

② Facia

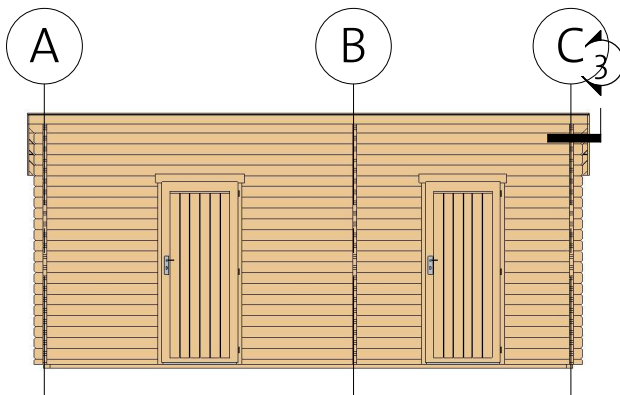
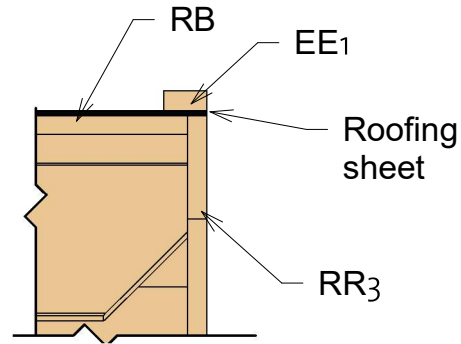
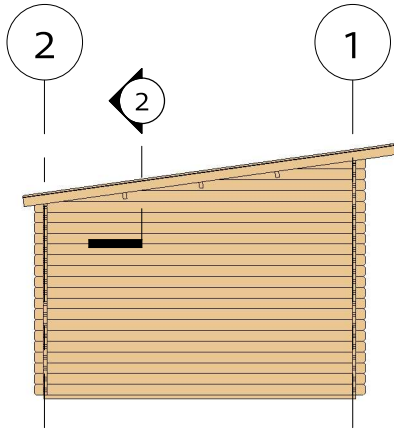

③ Roof Reinforcement

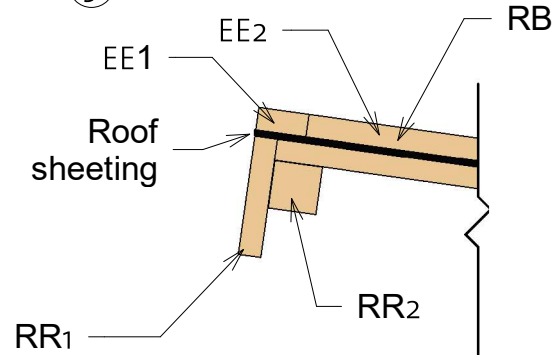

Fascia Schedule

Mark	Type	Profile	Count	Length
EE1	Eave Edging 18x40		1	5945
EE2	Eave Edging 18x40		2	3934
RR1	Roof reinforcement 18x95		2	5910
RR2	Roof reinforcement 38x38		2	5910
RR3	Roof reinforcement 18x95		2	3974

Kalle 40 (561x330)

Extras

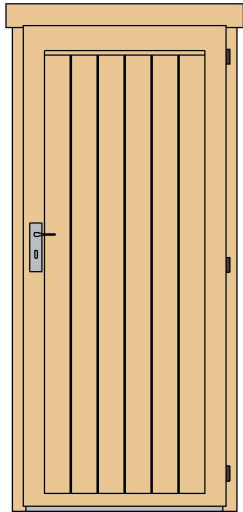

Door Schedule				
Mark	Type	Width	Height	Count
CD7R	Classic door 7, wood right	840	1955	2

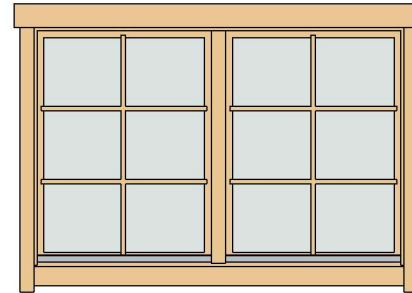

Window Schedule				
Mark	Type	Width	Height	Count
CDW1	Classic double window 1	1530	990	1
WCB6	Windows Crossbar 6	--	--	2

Fasteners & Extras		
Name	Type	Count

Hitblock	300-400 mm	
Screws	5,0 x 70	15
Bolts	M8 x 70	18
Screws	6,0 x 140	60
Nails	1,4 x 40	65
Screws	4,0 x 40	110
Screws	4,0 x 50	650

Mark	Model	Count	Length
WB1	Windboard 18x40	3	2450
WB2	Windboard 18x40	3	2200



Kalle 40 (561x330)

List of all items 1





Impregnated foundation beams

Mark	Type	Profile	Count	Length
IFB1	IFB 70x40		7	5460
IFB2	IFB 70x40		2	3290



Floor Schedule

Mark	Type	Profile	Count	Length
FB	FB 17x114		52	3214
BB1	BB 20x40		2	5610
BB2	BB 20x40		4	3300

Fascia Schedule

Mark	Type	Profile	Count	Length
EE1	Eave Edging 18x40		1	5945
EE2	Eave Edging 18x40		2	3934
RR1	Roof reinforcement 18x95		2	5910
RR2	Roof reinforcement 38x38		2	5910
RR3	Roof reinforcement 18x95		2	3974

Roof

Mark	Type	Profile	Count	Length
RFB	Beam 40x143		3	5910
RB	17x114		53	3936

Kalle 40 (561x330)

List of all items 2

Wall 1			
Mark	Profile	Count	Cut Length

1BL-1	40X57	1	1330
1BL-2	40X57	1	1935
1BL-3	40X57	1	845
1LG-1	40X114	17	845
1LG-2	40X114	17	1935
1LG-3	40X114	17	1330
1LG-4	40X114	4	5810
1TL-1	40X114	1	5910

Wall A			
Mark	Profile	Count	Cut Length

ALG-1	40X114	1	509
ALG-2	40X114	1	1323
ALG-3	40X114	1	2138
ALG-4	40X114	1	2953
ALG-5	40X114	1	3500
ALG-6	40X114	18	3500

Wall C			
Mark	Profile	Count	Cut Length

CLG-1	40X114	1	509
CLG-2	40X114	1	1323
CLG-3	40X114	1	2138
CLG-4	40X114	1	2953
CLG-5	40X114	1	3500
CLG-6	40X114	18	3500



Wall 2			
Mark	Profile	Count	Cut Length

2BL-1	40X57	1	5810
2LG-1	40X114	9	500
2LG-2	40X114	9	3770
2LG-3	40X114	8	5810
2TL-1	40X114	1	5910

Wall B			
Mark	Profile	Count	Cut Length

BLG-1	40X114	1	509
BLG-2	40X114	1	1323
BLG-3	40X114	1	2138
BLG-4	40X114	1	2953
BLG-5	40X114	1	3500
BLG-6	40X114	18	3500

Log Profiles	
Profile	Profile

40X57	
40X114	

Log Profiles	
Profile	Profile

40X114	
--------	---